

GÖLZ®



Core Drill Equipment

www.golzgroup.com

The compact, lightweight and easy solution for all installation and fastening holes from Ø 10 - 162 mm

User friendly, lightweight and self-explanatory

- Lightweight aluminum core drill stand with small anchor base and 2 speed hand held core drill
- Advantage: Coring can be operated hand held or with drill stand
- Lightweight and solid drill stand: 12 kg
- Travel length: 490 mm
- Maximum diameter: 162 mm
- Angle drilling device up to 45°
- Bubble levels for precise setup
- Left and right handed operation
- Laser pointer for accurate setup
- Aluminium anchor-/vacuum base
- Tool- and fastening kit included
- Accessories: (page 34-37)
- Drill Bits, see our Diamond Tools catalogue



GÖLZ Drilling Systems

GÖLZ-KB110 with anchor base			Drill bit connection 1¼" UNC + R1/2" or R1/2"	
Complete with	Power	RPM	Drilling Diameter	Order number
FB23P - 1¼" UNC + R1/2"	2200 W, 230 V, 50-60 Hz	520/1400 min ⁻¹	Ø 20-162 mm	0295 110 6033
FB25P - R1/2"		1400/2900 min ⁻¹	Ø 10-70 mm	0295 110 6035
Drill Stand KB110	with ring collar and tool kit, (without fastening kit), anchor base			0295 110 6030

Accessories	Order number
Water & Slurry Collectors	see page 34
Water Tank 50 liter	0295 150 0600

Reliable core drilling machine for all installation holes for heating, air condition and ventilation, electric and water installations up to Ø 250 mm

Lightweight aluminium drill stand with 2-speed core drill motor and anchor-/vacuum base

- Lightweight and solid drill stand: 12 kg
- Travel length: 650 mm
- Maximum diameter: 250 mm
- Angle drilling device up to 45°
- Bubble levels for precise setup
- Left and right handed operation
- Laser pointer for accurate setup
- Aluminium anchor-/vacuum base
- Tool- and fastening kit included
- Accessories: (page 34-37)
- Drill Bits, see our Diamond Tools catalogue



Lightweight and solid core drilling machine with roller carriage. The professional choice for all installation holes up to Ø 250 mm

KB 125 is the Complete Solution, equipped with a powerful 3500 Watt, 3-speed Core drill motor, quick motor disconnect system (STS), angle device and anchor-/vacuum base.

- Lightweight and solid drill stand: 12 kg
- Travel length: 650 mm
- Maximum diameter: 250 mm
- Angle drilling device up to 45°
- Motor quick release system (STS)
- Aluminium roller carriage provides a smooth and precise guiding
- Left and right handed operation
- Laser pointer for accurate setup
- Aluminium anchor-/vacuum base
- Tool- and fastening kit included
- Accessories: (page 34-37)
- Drill Bits, see our Diamond Tools catalogue



GÖLZ-DS250S with anchor-/vacuum base			Drill bit connection 1¼" UNC	
Complete with	Power	RPM	Drilling Diameter	Order number
GBM25	2500 W, 230 V, 50-60 Hz	360/850 min ⁻¹	Ø 52-250 mm	0295 125 9100
Drill Stand DS250S	with motor quick release system and tool kit (without fastening kit), anchor-/vacuum base, Weight 12 kg, up to Ø 250 mm			0295 125 9001

Accessories	Order number
Water & Slurry Collectors	see page 34
Water Tank 50 liter	0295 150 0600
Vacuum Pump VP 25	0295 010 0200
Vacuum Kit	0295 125 0008

GÖLZ-KB125 with anchor-/vacuum base			Drill bit connection EBL33 1¼" UNC + R1/2"; GBM25 1¼" UNC	
Complete with	Power	RPM	Drilling Diameter	Order number
EBL33L	2500 W, 230 V, 50-60 Hz	300/520/1.700 min ⁻¹	Ø 35-250 mm	0295 125 6017
Drill Stand KB125	with motor quick release system (STS) and tool kit (without fastening kit), anchor-/vacuum base, Weight 12 kg, up to Ø 250 mm			0295 125 6010

Accessories	Order number
Water & Slurry Collectors	see page 34
Water Tank 50 liter	0295 150 0600
Vacuum Pump VP 25	0295 010 0200
Vacuum Kit	0295 125 0008

Lightweight and professional core drilling machine for holes up to Ø 300 mm in building and construction industry

KB 250 with 3300 W Heavy User Core Drill motor is the professional solution, equipped with precise roller carriage, quick motor disconnect system (STS) and angle device.

- Lightweight and solid drill stand: 16 kg
- Travel length: 650 mm
- Maximum diameter: 300 mm
- Angle drilling device up to 45°
- Motor quick release system (STS)
- Aluminium roller carriage provides a smooth and precise guiding
- 2 -speed feeding by planetary gear (1:4 reduction)
- Left and right handed operation
- Laser pointer for accurate setup
- Aluminium anchor-/vacuum base
- Tool- and fastening kit included
- Accessories: (page 34-37)
- Drill Bits, see our Diamond Tools catalogue



GÖLZ-KB250 with anchor-/vacuum base			Drill bit connection 1 1/4" UNC	
Complete with	Power	RPM	Drilling Diameter	Order number
BBM33L-extra	3300 W, 230 V, 50-60 Hz	180/430/750 min ⁻¹	Ø 45-300 mm	0295 250 6006
GBM 30	3000 W, 230 V, 50-60 Hz	220/500/935 min ⁻¹	Ø 30-300 mm	0295 250 6007
Drill Stand KB250	with motor quick release system (STS) and tool kit (without fastening kit), anchor-/vacuum base, planetary gear, Weight 16 kg, up to Ø 300 mm			0295 250 6000

Accessories	Order number
Water & Slurry Collectors	see page 34
Water Tank 50 liter	0295 150 0600
Vacuum Pump VP 25	0295 010 0200
Vacuum Kit	0295 250 0050

The established and proven Core Drill Set for the construction site up to Ø 250 mm holes

Robust and rigid stainless steel column with brass sliding guided carriage, quick motor disconnect system (STS), angle device and anchor-/vacuum base.

- Stainless steel drill stand: 17 kg
- Travel length: 600 mm
- Maximum diameter: 250 mm
- Angle drilling device up to 45°
- Motor quick release system (STS)
- Left and right handed operation
- Aluminium anchor-/vacuum base
- Tool- and fastening kit included
- Accessories: (page 34-37)
- Drill Bits, see our Diamond Tools catalogue



GÖLZ-KB130 with anchor-/vacuum base			Drill bit connection 1 1/4" UNC + R1/2" or 1 1/4" UNC	
Complete with	Power	RPM	Drilling Diameter	Order number
EBL33L - 1 1/4" UNC + R1/2"	2500 W, 230 V, 50-60 Hz	300/520/1.700 min ⁻¹	Ø 35-250 mm	0295 130 6009
GBM25 - 1 1/4" UNC		360/850 min ⁻¹	Ø 52-250 mm	0295 130 6008
Drill Stand KB130	with motor quick release system (STS) and tool kit (without fastening kit), anchor-/vacuum base, Weight 17 kg, up to Ø 280 mm			0295 130 6000

Accessories	Order number
Water & Slurry Collectors	see page 34
Water Tank 50 liter	0295 150 0600
Vacuum Pump VP 25	0295 010 0200

Multipurpose core drilling machine for the sewer, road and building industry

Various motors and engines available:

Electric motors, Gasoline engine, Air motor and Hydraulic motor

Various operating conditions:

Coring in walls, floors, roads, sewer pipes

Various fastening options:

Anchors, vacuum, pipe bases, road bases

- Basic version for walls and floors with anchor base
- Travel length: 630 mm
- Double column with fine feeding carriage
- Motor quick release system (STS)
- Angle support
- Tool- and fastening kit included
- Drill stand weight: 27 kg
- Accessories: (page 34-37)
- Drill Bits, see our Diamond Tools catalogue

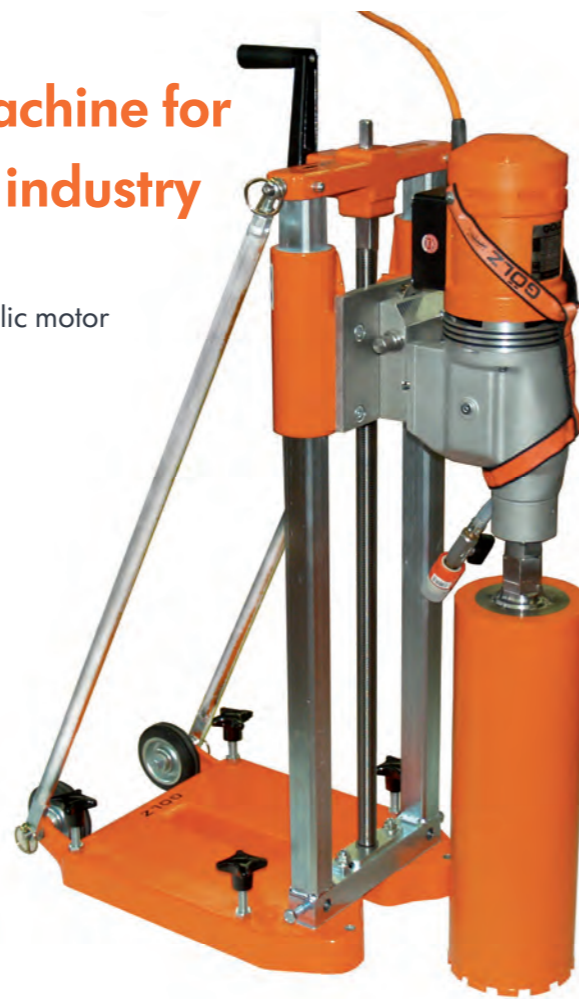

KB150 with STIHL-gasoline motor
2,8 kW (3,8 PS) 300 min⁻¹



Sewage converting kit
Easy mount and fix for drills in sewage pipes



KB150 with Air motor
6-7 bar, 280/600 min⁻¹



KB150 with hydraulic motor
140 bar, 300 min⁻¹ (HBM100)

GÖLZ-KB150 with anchor base		Drill bit connection 1¼" UNC (gasoline machine Gölz 3-bolt-flange)		
Complete with	Power	RPM	Drilling Diameter	Order number
Electric motor BBM33L-extra	3300 W, 230 V, 50-60 Hz	180/430/750 min ⁻¹	Ø 45-330 mm	0295 150 6010
Gasoline motor STIHL 2-Takt-Motor	2,8 kW (3,8 HP)	300 min ⁻¹	Ø 110 - 300 mm	0295 153 2000
Air motor LZL15	6-7 bar; 3,3 m ³ /min air consumption	600 min ⁻¹	Ø 50 - 150 mm	0295 152 6601
		280 min ⁻¹	Ø 110 - 300 mm	0295 152 3601
Hydraulic motor HBM50	140 bar 30 l/min oil consumption	610 min ⁻¹	Ø 50 - 150 mm	0295 150 3900
HBM100	140 bar 30 l/min oil consumption	300 min ⁻¹	Ø 150 - 300 mm	0295 150 3910
HBM160	140 bar 30 l/min oil consumption	190 min ⁻¹	Ø 250 - 330 mm	0295 150 3920
Drill stand KB150	with motor quick release system (STS) and tool kit (without fastening kit), anchor-/vacuum base, Weight 27 kg, up to Ø 330 mm			0295 151 6000

Accessories	Order number
Water Tank 50 liter	0295 150 0600
Water & Slurry Collectors	see page 34
Vacuum Pump VP 25	0295 010 0200
Vacuum Base	0295 150 0003
Steppless angle drilling	0295 150 0013
Sewage converting kit (cpl. with fastening strap, ratchet and 2 ground spikes)	0295 150 0001

Heavy User core drilling machine with combined slider/roller carriage, 2 speed feeding and angle device up to Ø 400 mm

Extended columns up to 2000 mm length as an option

- Travel length: 600 mm
- Stainless steel column with galvanised tooth rack
- Combined slider / roller carriage
- Motor quick release system (STS)
- 2 -speed feeding by planetary gear (1:4 reduction)
- Left and right handed operation
- Angle drilling device 60° positive/negative
- Tool- and fastening kit included
- Drill stand, weight 17,5 kg
- Accessories: (page 34-37)
- Drill Bits, see our Diamond Tools catalogue



GÖLZ-KB400 with anchor base			Drill bit connection 1¼" UNC	
Complete with	Power	RPM	Drilling Diameter	Order number
BBM33L-extra	3300 W, 230 V, 50-60 Hz	180/430/750 min ⁻¹	Ø 45-400 mm	0295 401 6010
Dolphin DX5L	5200 W, 400 V, 16 A	120/280/440 min ⁻¹	Ø 100-400 mm	0295 401 6020
Drill stand KB400	with motor quick release system (STS) and tool kit (without fastening kit), planetary gear, Weight 17,5 kg, up to Ø 400 mm			0295 401 6000

Accessories	Order number
Wheel Set	0295 401 9060
Extended column	on request
BorMatic	0295 600 0546
Backside support	0295 401 9030

Heavy User core drilling machine with combined slider/roller carriage, 2 speed feeding and angle device up to Ø 600 mm

Optional available up to ø 1000mm and travel length up to 2500 mm.

- Travel length: 600 mm
- Stainless steel column with galvanised tooth rack
- Combined slider / roller carriage
- Motor quick release system (STS)
- 2 -speed feeding by planetary gear (1:4 reduction)
- Left and right handed operation
- Angle drilling device 60° positive/negative
- Tool- and fastening kit included
- Drill stand, weight 26 kg
- Accessories: (page 34-37)
- Drill Bits, see our Diamond Tools catalogue



GÖLZ-KB500 with anchor base			Drill bit connection 1¼" UNC	
Complete with	Power	RPM	Drilling Diameter	Order number
BBM33L-extra	3300 W, 230 V, 50-60 Hz	180/430/750 min ⁻¹	Ø 45-400 mm	0295 501 6010
Dolphin DX5L	5200 W, 400 V, 16 A	120/280/440 min ⁻¹	Ø 100-500 mm	0295 501 6020
Drill stand KB500	with motor quick release system (STS) and tool kit (without fastening kit), planetary gear, Weight 26 kg, up to Ø 600 mm			0295 500 6020

Accessories	Order number
Wheel Set	0295 401 9060
Extended column	on request
BorMatic	0295 501 6000
Backside support	0295 501 9030

Autofeed with new steel sensor technology up to Ø 250 mm

Features

- Automatic feeding unit for core drilling
- single speed
- Steel -Stop sensor
- Autostop function by amp-control
- Automatic reduction of the feeding speed in steel
- Quick mount for Golz KB 400 and KB 500
- Best performance with BBM 33L-extra motor
- Compact size: (LxWxH): 166x195x275 mm
- Weight: only 6,3 kg



Your advantage

- Increased productivity through simultaneous use of 2 or more devices by one operator
- Drills faster than manual feed
- Longer life of diamond drill bits due to constant feeding pressure
- Low load of the drill motor by constant feeding pressure
- No load peaks

Specifications	BorMatic 80
Voltage	230 V, 50-60 Hz
Power Input/(Output)	52 W, 52 NM
Drilling Diameter	ø 50 - 250 mm
Working temperature	-5° C bis +40° C
Dimensions (LxWxH)	166 x 195 x 275 mm
Weight	6,3 kg
Order number	0295 600 0546



Autofeed unit for core drilling up to Ø 500 mm

Features

- Automatic feeding unit for core drilling
- 2- feeding speeds, 1:2
- For wide range of coring diameter (ø50-500mm)
- Autostop function by amp-control
- Automatic reduction of the feeding speed in steel
- Quick mount for Golz KB 400 and KB 500
- Best performance with BBM 33L-extra motor
- Compact size:(LxWxH): 248x189x280 mm
- Weight: 8,2 kg



Your advantage

- Increased productivity through simultaneous use of 2 or more devices by one operator
- Drills faster than manual feed
- Longer life of diamond drill bits due to constant feeding pressure
- Low load of the drill motor by constant feeding pressure
- No load peaks

Specifications	BorMatic 750
Voltage	230 V, 50-60 Hz
Power Input/(Output)	75 W, 52 NM
Drilling Diameter	ø 50 - 500 mm
Working temperature	-5° C bis +40° C
Dimensions (LxWxH)	248 x 189 x 280 mm
Weight	8,2 kg
Order number	0295 600 0541



GBM 25



Specifications	GBM 25
Voltage	230 V, 50-60 Hz
Power (Input/Output)	2,5 kW (1,75 kW)
RPM	360/850 min ⁻¹
Drilling Diameter	Ø 52-250 mm
Dril bit connection	1¼" UNC
Safety	PRCD
Weight	11,2 kg
Order number	0295 007 5480

EBL33L



Specifications	EBL33L
Voltage	230 V, 50-60 Hz
Power (Input/Output)	2,5 kW (1,75 kW)
RPM	300/520/1700 min ⁻¹
Drilling Diameter	Ø 20 - 250 mm
Dril bit connection	1¼" UNC + R1/2"
Safety	PRCD
Weight	6,5 kg
Order number	0295 007 5051

BBM33L-extra



Specifications	BBM33L-extra
Voltage	230 V, 50-60 Hz
Power (Input/Output)	3,30 kW (2,4 kW)
RPM	180/430/750 min ⁻¹
Drilling Diameter	Ø 45-400 mm
Dril bit connection	1¼" UNC
Safety	PRCD
Weight	13,2 kg
Order number	0295 007 5027

BBM33LL-extra



Specifications	BBM33LL-extra
Voltage	230 V, 50-60 Hz
Power (Input/Output)	3,30 kW (2,4 kW)
RPM	155/375/650 min ⁻¹
Drilling Diameter	Ø 50-470 mm
Dril bit connection	1¼" UNC
Safety	PRCD
Weight	13,2 kg
Order number	0295 007 5041

Dolphin DX5L



Specifications	Dolphin DX5L
Voltage	400 V
Power (Input/Output)	5,20 kW (3,7 kW)
RPM	120/280/440 min ⁻¹
Drilling Diameter	Ø 100-500 mm
Dril bit connection	1¼" UNC
Safety	---
Weight	22,5 kg
Order number	0295 007 5038

T1-200EL



Specifications	T1-200
Voltage	230 V, 50-60 Hz
Power (Input/Output)	2,20 kW (1,26 kW)
RPM	350/920/1280 min ⁻¹
Drilling Diameter	Ø 20 - 200 mm
Dril bit connection	1¼" UNC
Safety	PRCD
Weight	7,3 kg
Order number	0295 007 6001

GBM 30

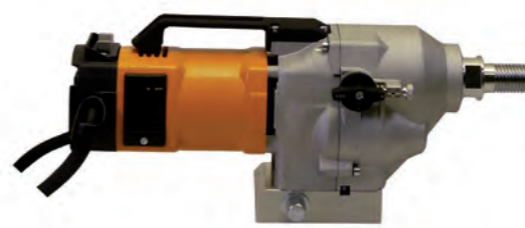

Specifications	GBM 30
Voltage	230 V, 50-60 Hz
Power (Input/Output)	3 kW (1,8 kW)
RPM	220/500/935 min ⁻¹
Drilling Diameter	Ø 30 - 300 mm
Dril bit connection	1¼" UNC
Safety	PRCD
Weight	12,2 kg
Order number	0295 007 6041

T9-475

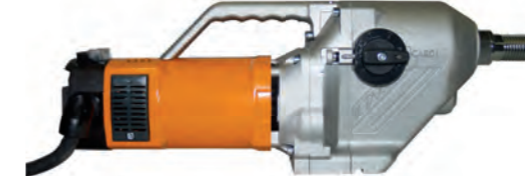

Specifications	T9-475
Voltage	230 V, 50-60 Hz
Power (Input/Output)	3,42 kW (2,22 kW)
RPM	165/315/515/1200 min ⁻¹
Drilling Diameter	Ø 100 - 500 mm
Dril bit connection	1¼" UNC
Safety	PRCD
Weight	14,5 kg
Order number	0295 007 6016

HBM-Reihe



Model	Power	RPM	Bohrbereich	Dril bit connection	Weight	Order number
HBM50	4,5 kW	610 min ⁻¹	Ø 50-150 mm	1¼" UNC	6 kg	0295 007 7050
HBM100	4,5 kW	300 min ⁻¹	Ø 150-300 mm	1¼" UNC	6,2 kg	0295 007 7100
HBM160	4,5 kW	190 min ⁻¹	Ø 250-333 mm	1¼" UNC	6,5 kg	0295 007 7160
HBM200	4,5 kW	150 min ⁻¹	Ø 400-600 mm	1¼" UNC	6,7 kg	0295 007 7200



GÖLZ KB200

Specially designed for taking core samples from roads or installing barrier posts and different kind of bollards

Due to its compact design and the complete package, the KB 200 is easy to use for:

- Core sampling in asphalt and concrete pavements
- Coring out of gate valves
- Coring to place barrier posts or different types of bollards
- Coring for airfield lightning
- Coring to place crash barriers or fences
- Travel length: 600 mm
- Twin column drill stand with road bases and roller guides
- Pressurized 10 liter water tank
- Exhaust gas hose, 4 m
- Tool- and fastening kit included
- Total weight with Stihl engine: 53 kg



Quick and flexible outdoor operation

Examples of use

- 1 Taking core samples.
- 2 Operators weight allows easy operation.
- 3 Drilling out water valves (Ø 200 mm / 8").

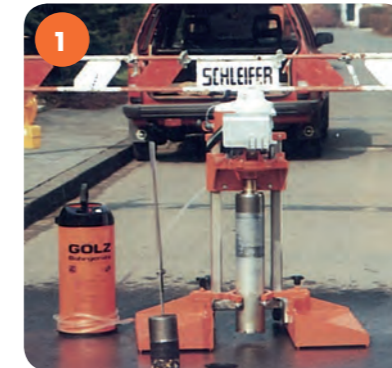

GÖLZ-KB200			Drill bit connection Gölz 3-bolt-flange	
Complete with	Power / Pressure	RPM	Drilling Diameter	Order number
Gasoline motor STIHL 2-stroke-motor	2,8 kW	300 min ⁻¹	Ø 110 - 280 mm	0295 203 2000
Electric motor BBM33L-extra	3,3 kW, 230 V, 50-60 Hz	180/430/750 min ⁻¹	Ø 50 - 280 mm	0295 203 2010
Air motor LZL15	6-7 bar, 3,3 m ³ /min air consumption	600 min ⁻¹	Ø 100 - 280 mm	0295 203 2020
Accessories				Order number
Core tongs for core sample Ø 50 mm				0296 000 0082
Core tongs for core sample Ø 100 mm				0296 000 0088
Core tongs for core sample Ø 150 mm				0296 000 0092
Core tongs for core sample Ø 200 mm				0296 000 0096



GÖLZ KB350

The ORIGINAL and most modern solution in pipe and sewage drilling for house connections and surface water with GÖLZ KB 350 and Stihl-2-stroke-engine

- > Most advanced design
- > Top class components by magnesium high-pressure die casting
- > compact and lightweight design, approved to operate under constricted space
- > Proven STIHL-Engine technology combined with GÖLZ Equipment concept ensure highest reliability, efficiency and safety in operation
- > Independant operation- where no public power supply is available.



Gölz KB 350 standard package

- Drill stand, travel length 450 mm, Pipe base, self centering
- Ground frame with 2 ground fixing spikes
- Fastening strap 2,1 meter with clamping ratchet for fixing directly on sewage pipe
- STIHL 2-stroke-engine, 2,8 kW (3,8 PS)
- Exhaust gas hose, 4m
- Gearbox with water swivel, 300 rpm
- Drilling diameter: max ø 354 mm
- Drill bit connection: Gölz 3-bolt-flange
- Pressurized 10 liter water tank
- Total weight with Stihl engine: 45 kg

Problem solution for house connection in sewage pipes

Examples

- 1 90° drill in sewage pipe. Fixing by ground spikes.
- 2 90° drill in concrete pipe. Fixing by vacuum pads (accessory).
- 3 90° drill in sewage pipe. Pipe base clamped between concrete pipe and trench and secured by ground spikes.
- 4 45° drill in cast iron pipe. Fixing by strap, clamping ratchet and angle support (accessory).

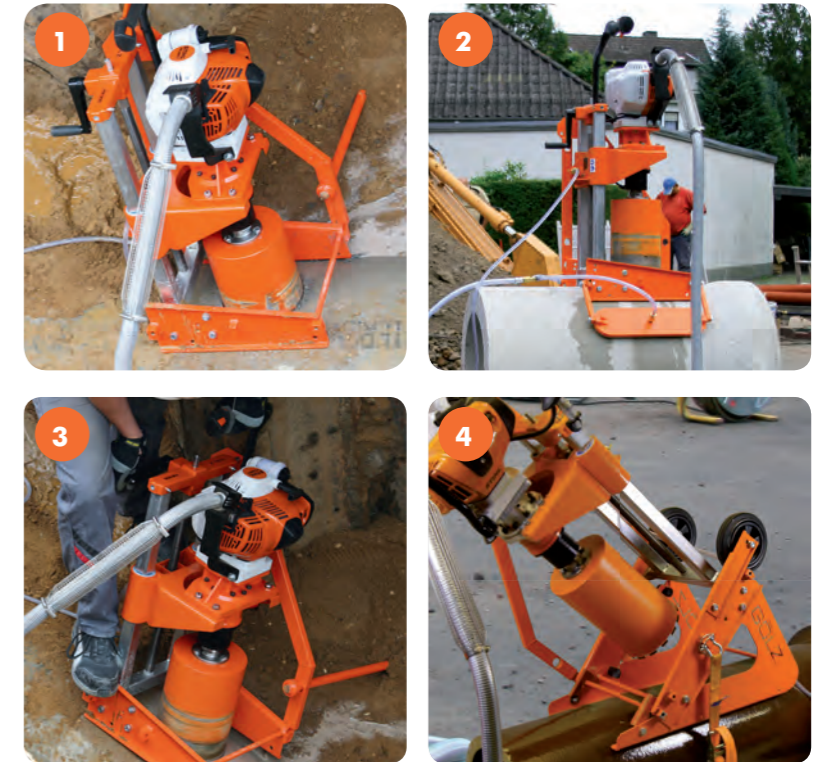

The KB350 drill stand is available with petrol-, hydraulic-, air-, or electric motor.



Hydraulic motor HBM100
Specifications see at page 25



Air motor LZL15
Specifications see at page 25

For use in any mounting position!

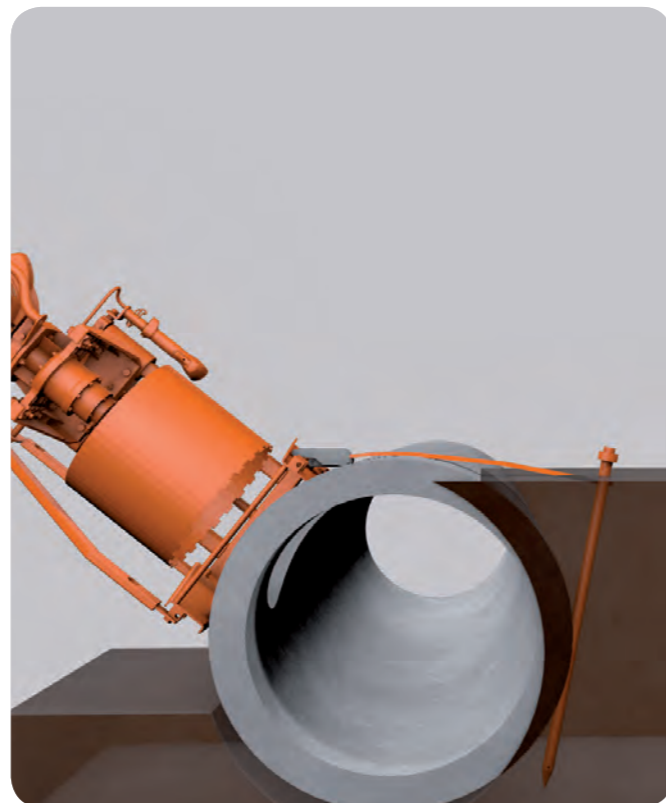
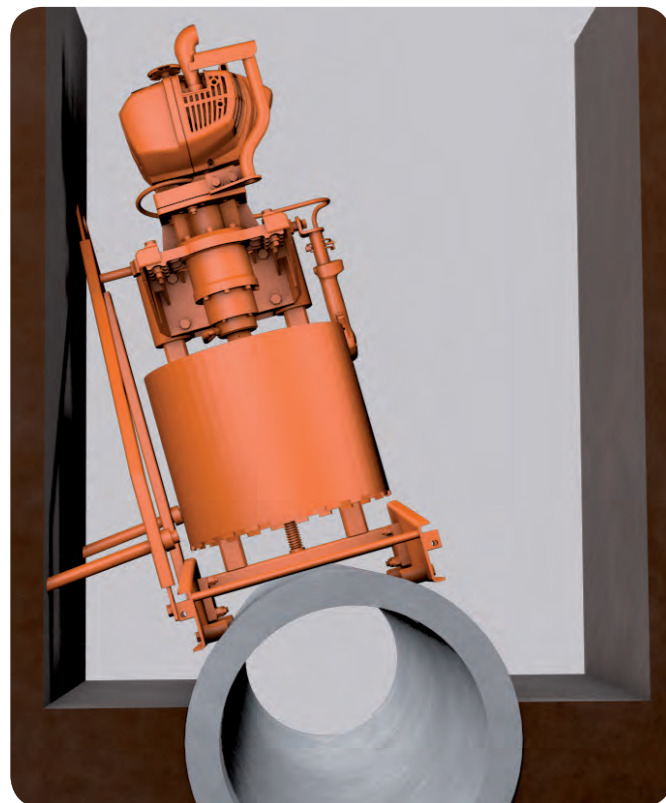
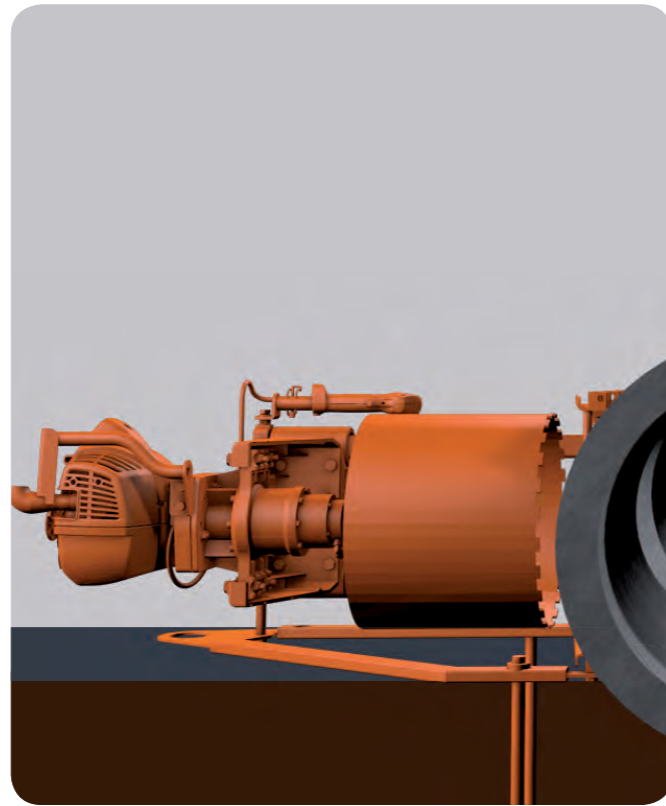

Accessories KB350



GÖLZ-KB350 Drill bit connection Gölz 3-bolt-flange

Complete with	Power / Pressure	RPM	Drilling Diameter	Order number
Gasoline motor STIHL 2-Takt-Motor	2,8 kW	300 min ⁻¹	Ø 110 - 354 mm	0295 353 2000
Electric motor BBM33L-extra	3,3 kW, 230 V, 50-60 Hz	180/430/750 min ⁻¹	Ø 45-354 mm	0295 353 2010
Air motor LZL15	6-7 bar, 3,3 m ³ /min air consumption	600 min ⁻¹	Ø 110 - 280 mm	0295 353 2020
Hydraulic motor HBM100	140 bar, 30 l/min oil consumption	300 min ⁻¹	Ø 110 - 354 mm	0295 353 2030

Accessories Order number

Excavator conversion kit	0295 003 0065
45° Angle support	0295 003 0060
Vacuum pump VP 25	0295 010 0200
Wheel Set	0295 003 0070
Set of vacuum pads	0295 300 0003
Set of road bases	0295 300 0005
Set of roller guidance	0295 300 0006
Frame extensions for pipes smaller DN300	0295 300 0011
Strap 2,1m incl. fixing device	0295 300 0053
Strap 4,0m	0295 300 0054
Strap 8,0m	0295 300 0058
Clamping ratchet	0295 300 0051
Exhaust gas hose 4,0m	0295 010 0014

Single Speed Dry Drilling Hand Held Core Drill. Dry drilling with and without dust collection for switches and junction boxes

- Easy to use single speed drill for holes up to 160 mm with diamond core bits
- No vibrations, no impact drilling
- Dry drilling in soft bricks and blocks, porcelain, porous concrete, sand-lime bricks
- Thermal overload protection
- Accessories: Dry core bits, Dustcollector, see Diamondtools catalogue (page 29)



Specifications	GÖLZ TB10S
Operation	Dry
Style	D-handle
Motor	Single phase, 230 V, 50 Hz
Power	1,8 kW (1,2 kW)
RPM	1200 min ⁻¹
Gears	1
Bit-ø in Brickwork (Dry)	Ø up to 160 mm
Drill bit connection	M18 male
Water connection	---
Ring collar Ø	53 mm
Dimensions (LxWxH)	460x95x320 mm
Weight	5,7 kg
Order number	0295 007 6050

2-Speed Heavy Duty Hand Held Core Drill. Compact Core Drill for anchor and installation holes

- 2-Speed Gearbox
- Drill Bit connection 1 1/4" UNC + R 1/2" oder R1/2"
- PRCD integrated in the power cord
- Electronic softstart and overload protection
- FB23P - wet & dry use up to ø200 mm
- FB25P- wet use, up to ø70 mm
- Horizontal & Vertical Bubble Levels
- Toolset SW32 & SW41 inclusive



Specifications	GÖLZ FB23P	GÖLZ FB25P
Operation	Wet & Dry	Wet
Style	Pistol-handle	
Motor	Single phase, 230 V, 50 Hz	
Power	2,2 kW (1,5 kW)	
RPM	520/1400 min ⁻¹	1400/2900 min ⁻¹
Gears	2	
Bit-ø in Concrete (Wet)	10 - 110 mm – Hand held 10 - 160 mm – Stand mounted	10 - 70 mm - Hand held 10 - 70 mm - Stand mounted
Bit-ø in Brickwork (Dry)	20 - 200 mm - Hand held, (Optional dust collector)	
Drill bit connection	1 1/4"UNC + R1/2"	R1/2"
Water connection	Gardena	
Ring collar Ø	60 mm	
Dimensions (LxWxH)	396x100x295 mm	337x100x295 mm
Weight	5,9 kg	5,6 kg
Order number	0295 007 5020	0295 007 5025

Accessories	Order number
Carrying Case	B802223
Drill Stand DS160S	0295 110 9010
Drill Stand KB125	0295 125 6000



3-Speed Heavy Duty Hand Held Core Drill. Powerful core drill with full metal housing for hand held or drill stand operation

- 3-Speed Gearbox
- Drill Bit connection 1 1/4" UNC + R 1/2"
- PRCD integrated in the power cord
- Softstart and thermal overload protection
- FB33P - wet use up to ø160 mm
- FB33S - wet & dry use up to ø200mm
- Horizontal & Vertical Bubble Levels
- Toolset SW32 & SW41 inclusive



Specifications	GÖLZ FB33P	GÖLZ FB33S
Operation	Wet	Wet & Dry
Style	Pistol-handle	D-handle
Motor	Single phase, 230 V, 50 Hz	
Power	2,2 kW (1,5 kW)	
RPM	520/1400/2900 min ⁻¹	
Gears	3	
Bit-ø in Concrete (Wet)	20 - 110 mm - Hand held 20 - 160 mm - Stand mounted	20 - 110 mm - Hand held 20 - 160 mm - Stand mounted
Bit-ø in Brickwork (Dry)	20 - 200 mm - Hand held (Optional dust collector)	20 - 200 mm - Hand held, Dust collector integrated
Drill bit connection	1 1/4" UNC + R1/2"	
Water connection	Gardena	Geka-coupling
Ring collar Ø	60 mm	
Dimensions (LxWxH)	422x100x295 mm	562x100x150 mm
Weight	6,5 kg	
Order number	0295 007 5064	0295 007 5073

Accessories	Order number
Carrying Case	B802223
Drill Stand DS160S	0295 110 9010
Drill Stand KB125	0295 125 6000



3-Speed Hand Held Core Drill. For hand held or drill stand operation

- 3-Speed Gearbox
- Drill Bit connection 1 1/4" UNC + R 1/2"
- PRCD integrated in the power cord
- Thermal overload protection
- Wet & Dry use in Concrete and Brickwork
- Horizontal & Vertical Bubble Levels
- Toolset SW32 & SW41 inclusive



Specifications	GÖLZ FB20P
Operation	Wet & Dry
Style	Pistol-handle
Motor	Single phase, 230 V, 50 Hz
Power	2,2 kW (1,5 kW)
RPM	450/1200/2500 min ⁻¹
Gears	3
Bit-ø in Concrete (Wet)	20 - 110 mm - Hand held 20 - 160 mm - Stand mounted
Bit-ø in Brickwork (Dry)	20 - 200 mm - Hand held
Drill bit connection	1 1/4" UNC + R1/2"
Water connection	Gardena
Ring collar Ø	60 mm
Dimensions (LxWxH)	432 x 119 x 272 mm
Weight	6,7 kg
Order number	0295 007 5080

Accessories	Order number
Carrying Case	B802223
Drill Stand DS160S	0295 110 9010
Drill Stand KB125	0295 125 6000



Light and modern Aluminium Core Drill Stands with sliding guide carriage



DS160S

DS250S

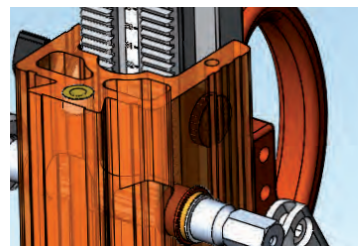
DS300S



high quality sliding guide carriage

Specifications	GÖLZ DS160S	GÖLZ DS250S	GÖLZ DS250S	GÖLZ DS300S	GÖLZ DS300S
Max. Diameter	Ø 162 mm	Ø 200 mm	Ø 250 mm	Ø 300 mm	Ø 300 mm
Column	Aluminium	Aluminium	Aluminium	Aluminium	Aluminium
Travel length	490 mm	650 mm	650 mm	650 mm	650 mm
Angle drilling device	up to 45°	up to 45°	up to 45°	up to 45°	up to 45°
Bases	anchor-/vacuum base	anchor-/vacuum base	anchor-/vacuum base	anchor-/vacuum base	anchor base
Carriage	Sliding guide carriage	Sliding guide carriage	Sliding guide carriage	Sliding guide carriage	Sliding guide carriage
Dimensions (LxWxH)	490x260x900 mm	450x290x950 mm	450x290x950 mm	400x290x1050	475x350x1050 mm
Weight	11 kg	12,5 kg	12,5 kg	17,8 kg	18 kg
Motor connection	Ring collar Ø60 mm	Ring collar Ø60 mm	Motormount	Motormount	Motormount
	✓	✓			
			✓	✓	✓
Order number	0295 110 9010	0295 125 9010	0295 125 9020	0295 250 9010	0295 250 9020

Light and professional Aluminium Core Drill Stands with roller carriage

KB110

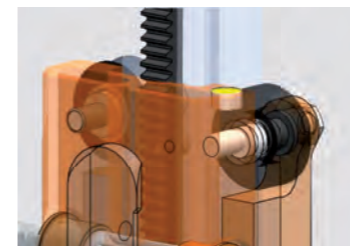

KB125

KB250



high quality roller carriage

 incl. laser pointer!

Specifications	GÖLZ KB110	GÖLZ KB125	GÖLZ KB125	GÖLZ KB250	GÖLZ KB250
Max. Diameter	ø 162 mm	ø 200 mm	ø 250 mm	ø 300 mm	ø 300 mm
Column	Aluminium	Aluminium	Aluminium	Aluminium	Aluminium
Travel length	490 mm	650 mm	650 mm	650 mm	650 mm
Angle drilling device	up to 45°	up to 45°	up to 45°	up to 45°	up to 45°
Bases	anchor-/vacuum base	anchor-/vacuum base	anchor-/vacuum base	anchor-/vacuum base	anchor base
Carriage	Roller Carriage	Roller Carriage	Roller Carriage	Roller Carriage	Roller Carriage
Dimensions (LxWxH)	310x255x890 mm	505x360x945 mm	505x360x945 mm	315x215x1090 mm	270x220x1090 mm
Weight	10 kg	12 kg	12 kg	15,5 kg	15,5 kg
Motor connection	Ring collar Ø60 mm	Ring collar Ø60 mm	STS Motormount	STS Motormount	STS Motormount
	✓	✓			
			✓	✓	✓
Order number	0295 110 6000	0295 125 6000	0295 125 6012	0295 250 6002	0295 250 6022

Robust and solid core drill stands from stainless steel

Core drill stands from stainless steel for heavy users

KB130

KB150

KB400

KB500



Specifications	GÖLZ KB130	GÖLZ KB130	GÖLZ KB150
Max. Diameter	Ø 250 mm	Ø 250 mm	Ø 330 mm
Column	Stainless steel	Stainless steel	Stainless steel
Travel length	600 mm	600 mm	630 mm
Angle drilling device	up to 45°	up to 45°	up to 45°
Bases	anchor-/vacuum base	anchor base	anchor base
Carriage	Brass-sliding carriage	Brass-sliding carriage	Sliding guide carriage
Dimensions (LxWxH)	400x340x930 mm	270x220x1110 mm	585x350x1000 mm
Weight	16,5 kg	16,5 kg	27 kg
Motor connection	STS Motormount	STS Motormount	STS Motormount
	✓	✓	✓
Order number	0295 130 6002	0295 130 6022	0295 151 6002

Specifications	GÖLZ KB400	GÖLZ KB500
Max. Diameter	Ø 400 mm	Ø 600 mm
Column	Stainless steel	Stainless steel
Travel length	600 mm	600 mm
Angle drilling device	60° positive/negative	60° positive/negative
Bases	anchor base	anchor base
Carriage	Roller/Sliding carriage	Roller/Sliding carriage
Dimensions (LxWxH)	425x316x1011 mm	460x325x1046 mm
Weight	17,5 kg	26 kg
Motor connection	STS Motormount	STS Motormount
	✓	✓
Order number	0295 401 6002	0295 501 6002

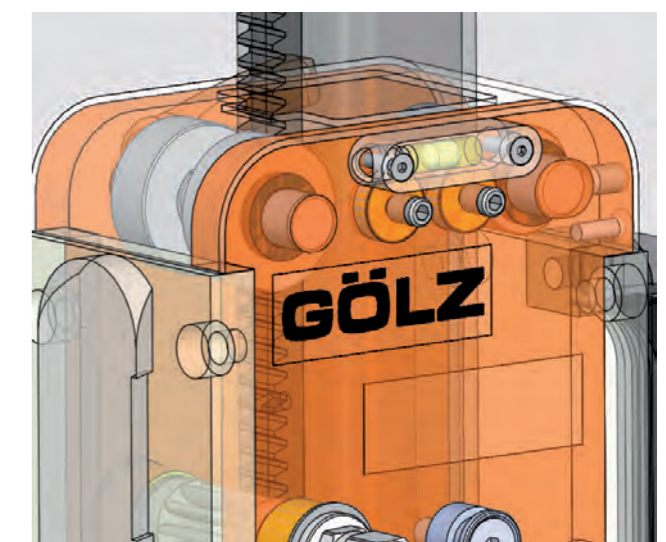

high quality roller/sliding carriage



Vacuum Pump VP 25

- 230 V, 250 Watt, 50 Hz, 1400 min-1, IP44
- Safety tank 5 l and vacuum breaker
- Suction volume: 25 l/min
- Dimensions (LxWxH): 370x200x500 mm
- Weight: 12,7 kg

Order number: 0295 010 0200

Vacuum Kit for Aluminum Drill Stands



consisting of vacuum valve and rubber

- V-Kit KB 110 / DS 160 S
Order number: 0295 110 0012
- V-Kit KB 125 / DS 250 S
Order number: 0295 125 0008
- V-Kit KB 250 / DS 300 S
Order number: 0295 250 0050

Vacuum Base



for core drill stands with anchor base up to max. ø 200 mm
Dimensions (LxW): 420x325 mm
Order number: 0295 230 0500



Water Tank WB50E

- 12 Volt battery with charger
- Integrated submersible pump 19l/min @ 0,85bar
- 50l impact resistant plastic tank
- Operates up to 8 hours with one battery charge
- Battery load indicator
- Water hose, 6 m long with gardena coupling
- Cart foldable for easy transport
- Weight: 32 kg

Order number: 0295 150 0600

Water Tank



- 10 l pressurized water tank
 - Incl. 4 m water hose
 - With GÖLZ-MK-coupling for KB 200 and KB 350 with Stihl engine
 - For core drill motors and core drilling machines with gardena-hose-coupling
- Order number: 0295 010 0020
Order number: 0295 010 0021

Submersible Pump



- Portable for core drilling with a water supply from a water tank or barrel
 - 220 V, 50 Hz
 - Max flow rate 80 l/min
- Order number: 1003 000 01

Water & Slurry Collectors

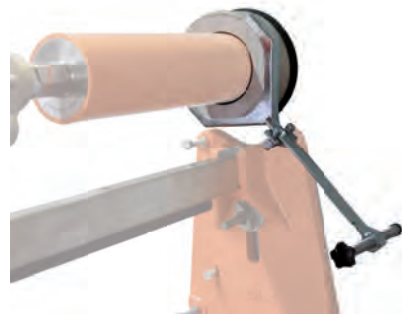

cpl. with universal fastener for all most common drill stands.

Available sizes:

- up to Ø 130 mm
Order number: 0295 000 6000
- up to Ø 180 mm
Order number: 0295 000 6001
- up to Ø 230 mm
Order number: 0295 000 6002

AP-Dust and Water Collector



- for clean, tidy operation
 - simply connect to dry or wetvac
 - Especially for the operation of hand held core drilling machines, dry or wet, and also for impact drills
 - up to Ø 140 mm drill bits
- Order number: 0295 150 0012

Wet Vac GS70K



- 230V, 50 Hz (110V, 50-60Hz)
 - 2 motors, each 1200 Watt
 - 70 liter capacity
- Order number: 0295 150 0302

Dry Vac S1625



- 230 V, 50 Hz, 1600 W
- 20 l capacity
- FKP 4300 fine particle filter
- Dust filtering: 99,9 %
- Coupler socket
- Impulse filter cleaner
- Accessories included
- Weight: 12,7 kg

Order number: 0295 100 1000

Planet Gear Feeding Reduction



- 2 feeding speed adapter
 - 1:4 reduction
 - for KB250, KB 400, KB 500
- Order number: 0295 000 0840



Motor Quick Release System (STS)

- Quick motor mount plate fits to all common core drill motors and all GÖLZ core drill stands with STS system
- Order number: 0295 110 0042**

Core Lifter

- for removing cores
- Order number: 0296 000 0080**



Slider Drill Bit Quick Release

- Easy disconnect the core bit from core drill motor
 - available for core drilling machines with 1 1/4" UNC core bit connection
- Quick Release XL for core drill motor up to 3,4 kW**
Order number: 0295 150 0112
- Quick Release XXL for core drill motor starting with 4 kW**
Order number: 0295 150 0113



Motor-Distance-Plates

- Motorplate 20 mm
Order number: BD502545
- Motorplate 45 mm
Order number: BD501852

Fasteners and Fastening Kits

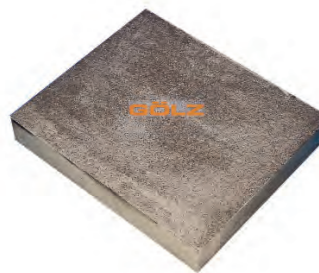

Abrasive Sharpening Block

- to sharp re-tipped or polished drill bits
 - Dimensions (LxWxH): 350x260x50 mm
- Order number: 0268 180 0014**

	FDBB expansion bolt Ø 16 mm	Order number: 0263 340 0011		M12, Rawl anchor rod 250 mm	Order number: 0267 120 0023
	FDBB anchor rod M12, 160 mm	0267 120 0027		M12, Wedge anchor rod 175 mm	0267 120 0024
	FDBB anchor rod M12, 250 mm	0267 120 0028		M12, Wedge anchor rod 250 mm	0267 120 0020
	FDBB anchor nut	0267 120 0019		6-hex anchor nut	0267 120 0011
	Washer	0295 000 0331		Quick anchor kit for wedge anchors M12 with anchor rod 130 mm and safety nut	0267 120 0030
	Rawl-anchor M12, Ø 20 mm	0263 370 0012			
	Wedge-anchor M12, Ø 16 mm	0263 370 0014			
	Fastening Kit FDBB cpl. FDBB anchor nut, washer, SDS+ impact drill 16mm, 5x FDBB-expansion bolts, FDBB anchor rod 160 mm	0295 110 0992			



Support Jack

- For bracing a drill stand between floor and ceiling
 - Adjustable from 1,80m - 3,00 m
- Order number: 0295 130 0030**



GÖLZ® - Group

GÖLZ GmbH

Dommersbach 51 | 53940 Hellenthal-Blumenthal

Telefon +49 2482 12-0 | Fax +49 2482 12-222

info@goelz.de | www.goelz.de

ÖSTERREICH

Gölz Ges.m.b.H.

Samstr. 52 | A-5020 Salzburg

Telefon +43 662 438175 | Fax +43 662 430734

info@goelz.at | www.goelz.at

FRANKREICH

Gölz S.A.S.

Espace Laiterie | 1, rue de la Mairie | F-67370 Berstett

Telefon +33 3 88 59 43 00 | Fax +33 3 88 59 47 77

info@golz.fr | www.golz.fr

GROSSBRITANNIEN

Golz (UK) Ltd.

Unit A5 | Springhead, Enterprise Park

Northfleet | Kent DA 11 8HB

Telefon +44 1 474 321 679 | Fax +44 1 474 321 477

info@goelz.co.uk | www.golzuk.com

BENELUX

Gölz Benelux N.V. Belgien

Eupener Straße 61 | B-4731 Raeren-Eynatten

Telefon +32 87 55 23 49 | Fax +32 13 78 33 28

benelux@goelz.de | www.golzgroup.com

USA

Golz L.L.C.

5860 East Osage Ridge Lane | Columbia MO 65203-6018

info@golzusa.com | www.golzgroup.com



Your GÖLZ dealer

